

## **Analysis, optimization and modelling of electrical energies produced by the photovoltaic panels and systems**

M. El Ouariachi, T. Mrabti, M.F. Yaden, Ka. Kassmi and K. Kassmi

Université Mohamed Premier, Faculté des Sciences, Laboratoire LEPAS, Oujda, Maroc

(reçu le 12 Mai 2010 – accepté le 27 Décembre 2011)

**Abstract** – *The works realized in this article concern the simulation in Pspice and the experimentation operation of the photovoltaic (PV) panels and systems. We have analyzed the optimal operation of PV panels as a function of the weather conditions (solar irradiation, temperatures...), and design of a PV system provided with MPPT command ensuring instantaneously the optimal operation of photovoltaic panels. The various results obtained show that the optimal electrical properties (voltage, current and power) of photovoltaic panels depend on the solar irradiation and the panels association (parallels or series). Also, the photovoltaic system optimizes the operation of PV panels independently the load nature: number of batteries,...*

**Résumé** - *Les travaux réalisés dans cet article concernent la simulation par Pspice et l'expérimentation des panneaux photovoltaïques (PV) et du système. Nous avons analysé le fonctionnement optimal de modules photovoltaïques en fonction des conditions météorologiques (ensoleillement, température ...), et la conception d'un système photovoltaïque fourni avec la commande MPPT pour en assurer instantanément le fonctionnement optimal des modules photovoltaïques. Les différents résultats obtenus montrent que les propriétés optimales électriques (tension, courant et puissance) des modules photovoltaïques dépendent du rayonnement solaire et de l'association des modules (parallèle ou série). En outre, le système PV optimise le fonctionnement des panneaux photovoltaïques indépendamment de la nature de la charge: le nombre de batteries, ...*

**Keywords:** Cells and Photovoltaic panels - Electric characterization - Pspice simulator - Maximum power point (PPM) - System photovoltaic - Converter DC-DC - MPPT command.

### **1. INTRODUCTION**

The progressive exhaustion of the traditional energy sources and harmful increase of greenhouse effect, generated by fossil fuels, pushed the scientists to have recourse to new renewable energies, non polluting. Among these energies one finds the energy photovoltaic (PV) whose electrical energy is produced by PV panels [1-4].

In the field of PV energies and their applications, the fine modelling of the operation electrical of the PV panels is essential [5]. This will allow on one hand to qualify the technological process of PV cells realization, and one another hand to analyze the optimal operation as well as the ageing of PV panels. This last study is necessary in order to design and to realize adequate PV systems allowing the follow-up of the maximum power point (MPP) [2-12].

Currently, one finds in the literature a few results concerning the fine modelling of the electrical operation of PV panels and systems as a function of the weather conditions (solar radiation, temperature...), PV association (parallels or series) and nature of the charge (batteries,...).

In this work, we have analyzed in the Pspice simulator, the electric operation of PV panels (silicon) currently marketed as a function of solar irradiation and of the temperature. Particularly, we have studied the electric model and the MPP of the panels as a function of the weather conditions (solar irradiation and temperature).

Basing on these results, we have studied in Pspice the design of a PV system provided with an analogical MPPT (Maximum Power Point tracking) command of low cost. We have analyzed the possibility of follow up the MPP of PV panel by the command thus designed.

The various results will be validated from the characterization of PV system carried out according to PV panels associated in parallel and batteries (12 V) associated in series. Our essential objective is to show the feasibility of this command in order to make reliable its realization and its operation during all day.

## 2. PHOTOVOLTAIC PANELS

### 2.1 Model of PV panels

PV Panel used in our study is formed of 36 cells in series (Fig. 1). A PV cell is formed by the short-circuit current ( $I_{SC}$ ), the diode (D), the shunt resistance ( $R_{sh}$ ), and the series resistance ( $R_s$ ). The current of the diode depends on the technological parameters (dimensions of the PN junction, doping, mobilities of the carriers...) and of the temperature (T) according to the expression [13]:

$$I_D = I_s(T) \times \exp\left(-\frac{q \times V_D}{K_b \times T}\right) \quad (1)$$

where,  $I_s(T)$ : Saturation current of the diode,  $V_D$ : Voltage at diode terminals,  $q$ : Charge on an electron,  $K_b$ : Boltzman constant.

From the comparison of the simulations results obtained by the simulator Pspice and those provided by the manufacturer, we have deduced the various parameters of the diode and the PV cell ( $R_s$  et  $R_{sh}$ ), and dependence of the short-circuit current ( $I_{sc}$ ) with solar irradiation ( $I_e$  ( $W/m^2$ )) [3].

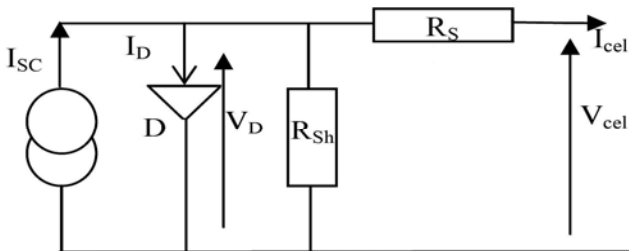

Fig. 1: Electric diagram of a PV cell

### 2.2 Analyzes operation of PV panels

We have characterized from, the measuring equipments set up at the laboratory (Fig. 2), the module during one day when the intensity of solar radiation varies from  $300 W/m^2$  to  $900 W/m^2$  and the temperature is around of  $25 ^\circ C$ .

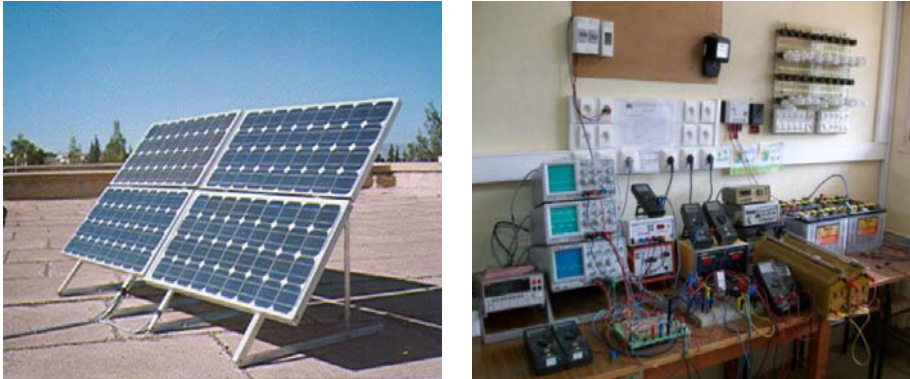

Fig. 2: Measuring equipments set up to characterize the photovoltaic panels and systems

In figure 3 we have represented the typical characteristics power current obtained. On the same figures we have represented the characteristics simulated in Pspice by fixing the parameters of the diode (saturations current ...) which allows a good agreement between the experiment and simulation.

The analysis of these characteristics show that the optimal ( $V_{opt}$ ) voltage decreases linearly with solar radiation. When solar radiation varies from 300 to 900  $W/m^2$ , the optimal voltage varies from 14.8 V to 13.2 V (a decreasing of 11 %).

In a PV installation the panels are associated in parallel and series. In such an installation, in parallel or series, it is essential to know the optimal performance of a panel. In our case, we have analyzed the characteristics power-voltage of two or three panels associated in parallel or in series.

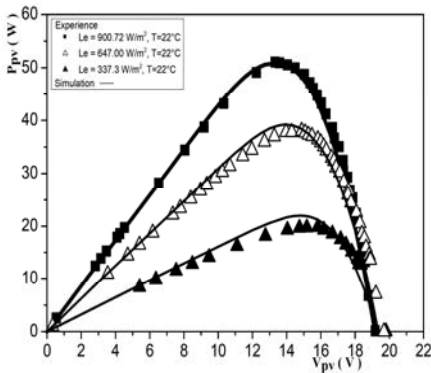

Fig. 3: Characteristics power-voltage experimental (■, Δ, ▽) and simulated in Pspice

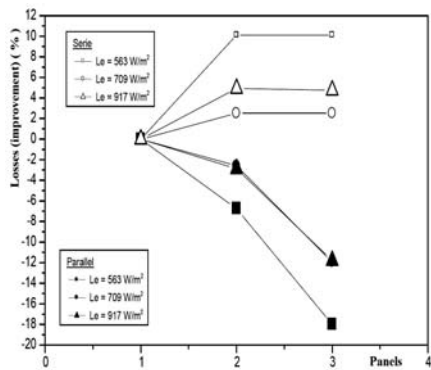

Fig. 4: Losses (improvement) of the optimal power of a panel during the association of the panels in parallel (series) as a function of solar irradiation.  
T: 22-25°C

Then, we have deduced the characteristics of one panel in such an association. We have observed that the optimal power of a panel is clearly improved (degraded) during the association of the panels in series (parallel).

In figure 4, we have represented the evolution of the losses (improvement) relative of the optimal power of a panel during the association of the PV panels in parallel (series). It appears that the putting the panels in series improves the optimal power of a panel. At low solar irradiation, the improvement can reach 10 % for two PV panels.

### 3. PHOTOVOLTAIC SYSTEMS

#### 3.1 Synoptic diagram and operation of the PV system blocks

In figure 5, is represented a block diagram of the PV system which is the object of our study. A system is formed by:

- PV panels analysed in paragraph 2.1.
- The load formed either by a resistance value higher than optimal panel [3, 4, 7], or by two batteries (115 Ah, 12 V) in series.
- A power circuit which is DC/DC converter of Boost type [3]. The converter is dimensioned so that it's operating a continuous mode at a frequency of switching of 10 kHz [3, 4, 7]. In this converter we used the transistor MOSFET (IRF540) as switch of the power, since it's presents a interesting performances for our application
- An analogical MPPT command which makes it possible to seek continues the MPP of PV generator. In our work we have more reliable the structure and functioning of the analogical MPPT commands studied in the literature [2, 14, 15] by introducing components that reduce the parasites and ensure perfect regulation control around the MPP.

Figure 6 shows the analogical MPPT command realised in the laboratory. This analogical command is characterized by its simplicity of realization, implementation and low cost. In addition it could operate at high switching frequencies (above 0.1 MHz).

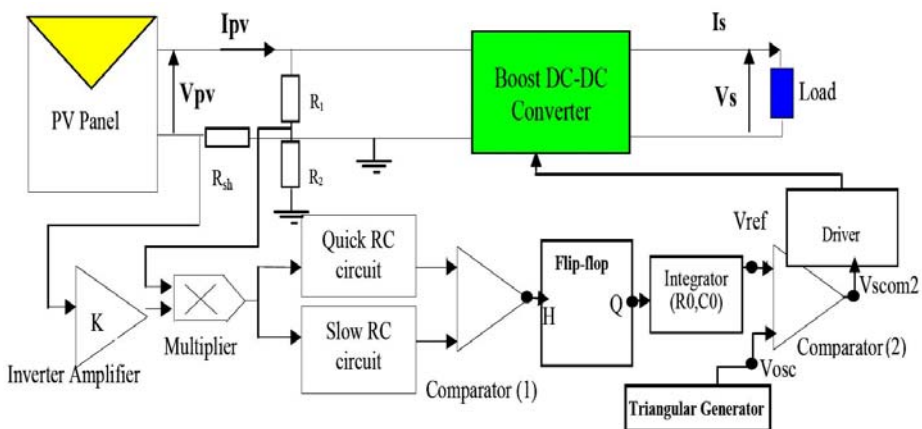

Fig. 5: Block diagram of analogical MPPT command

## 3.2 Electrical characterization

### 3.2.1 Operation of each block of the PV system

We have implanted the PV system of the Figure 5 in Ppsice simulator and deduced that the electrical characteristics of PV panel oscillate around the PPM. To validate these results, we realized the PV system designed (Fig. 5 and 6) when the load is formed by two batteries (115 Ah, 12 V) in series.

In Figure 7, we represented the typical signals of the flip-flop (clock H, output Q), the signals of reference ( $V_{ref}$ ), the signals of oscillator ( $V_{osc}$ ) and the signal of driver. It appears:

- The flip-flop changes the state when the clock signal switches to high state. This shows that the system evolves towards a decrease of the electrical power supplied by the PV panel, and this switches changes the direction of system evolution. When the clock signal switches to low state, the output Q does not change state.

This shows that the system evolves towards increasing of the electrical power of PV panel to reach the MPP. The shape of these signals shows that the operating point of PV panel oscillates around the point PPM

- The oscillator generates a periodic signal, its frequency is around 10 kHz and integrator R0C0 generates a reference signal  $V_{ref}$  slowly variable.
- The driver generates a rectangular signal of frequency about 10 kHz and duty cycle of 0.49. This last value is in very good agreement with that obtained by the simulations.

From the same figure 7, we deduce when closing (opening) of the switch the voltage input and output the DC/DC converter stabilize around optimal values (13.6 and 49.6 V). These results clearly show the good operation of the DC/DC Boost converter.

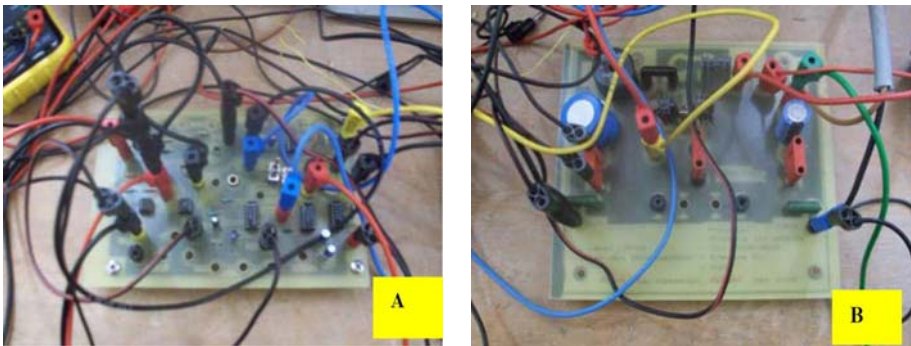

Fig. 6: Analogical MPPT control (A) and DC/DC Boost converter (B) realized in the laboratory

### 3.2.2 Complete PV system operation

We experimented, for given solar radiation, the operation of complete PV system (Fig. 5) according:

- the PV panels for two batteries in series (12 V, 115 Ah),
- the batteries connected in series for one PV panel.

For every experiment, we observed the absence of the instabilities observed on the PV system of the literature [2, 14], and convergence toward the instantaneous MPP. The typical results obtained of the voltage ( $V_{pv}$ ) and power ( $P_{pv}$ ) of PV panel, the duty cycle ( $\alpha$ ) of the signal that controls the Mosfet switch and the Boost DC/DC converter efficiency are shown in Figures 8 and 9. On the same figures we have represented the PV system simulations results in Pspice. It appears that:

- For every case of experiments a very good agreement between experiment and simulation.
- The values of the duty cycle ( $\alpha$ ) follow perfectly the variations of load or PV panels. This demonstrates the good command of the analogical MPPT control and therefore, the system convergence to the MPP.
- In the second case, where we vary the batteries, the obtained results is in very good agreement to those obtained in paragraph II.1 for modelling the electrical operation of PV panels.
- In the first case, where we vary the number of panels in parallel, there is clear, by comparing with the simulation, the electrical power supplied by the panels is degraded in such an association. When the association of three panels, the power loss is about 18 W (12 % loss). These values are in very good agreement with the results of Figure 4.
- The converter efficiency is slightly lower than simulated. The experimental values are satisfactory and are about 85 %. A work in progress on the MOSFET switches to improve the performance of converters and get efficiency about 90 %.

All results in this section show in one hand the good functioning of the PV system designed and realized in this work, and in other hand the validation of the results obtained by modelling the electric functioning of the PV panels [16]: model of the PV cell, decreases of the optimal voltage with illumination, power losses when we connected the PV panel in parallel.

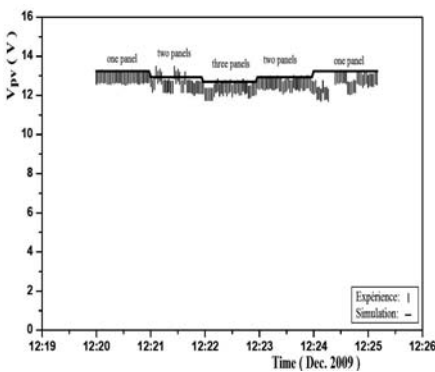

Voltage ( $V_{pv}$ ) of PV panel

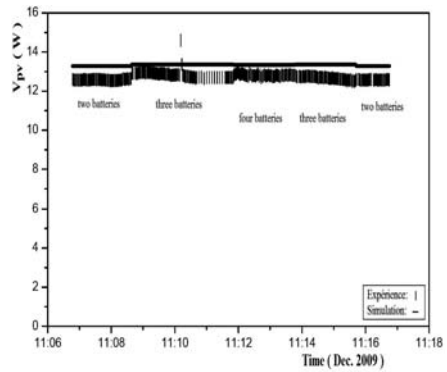

Voltage ( $V_{pv}$ ) of PV panel

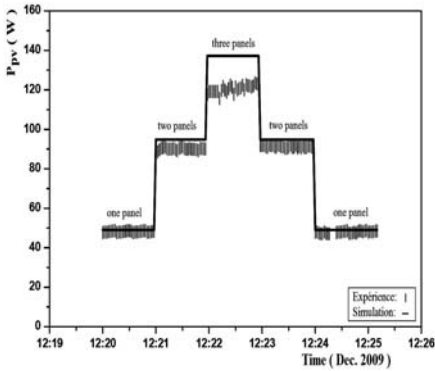

Power ( $P_{pv}$ ) of PV panel

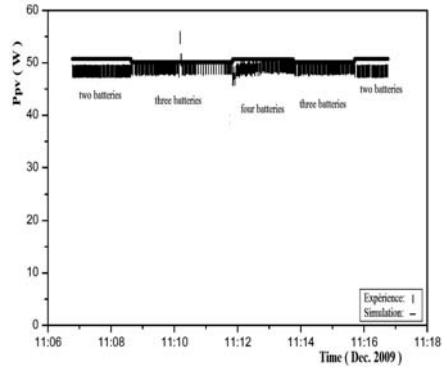

Power ( $P_{pv}$ ) of PV panel

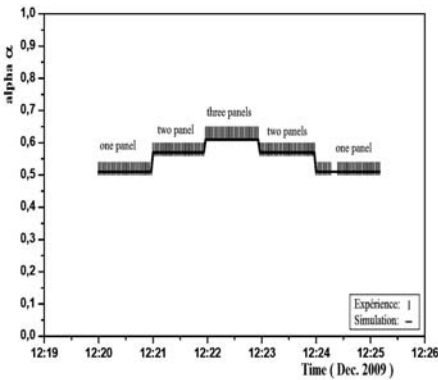

Duty cycle ( $\alpha$ ) of the signal which control Mosfet switch

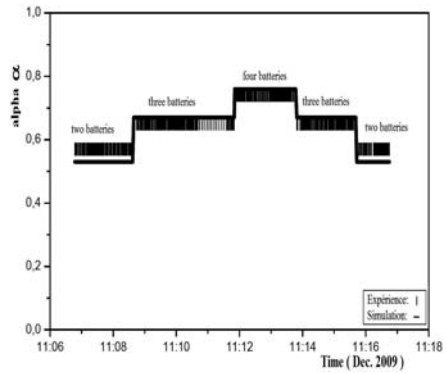

Duty cycle ( $\alpha$ ) of the signal which control Mosfet switch

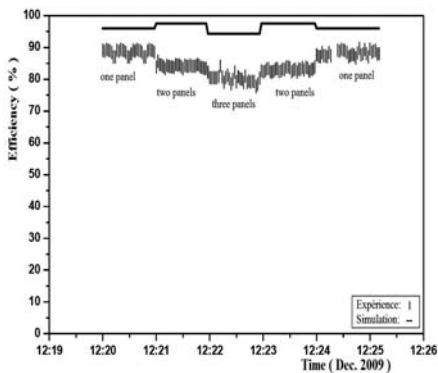

Boost converter efficiency

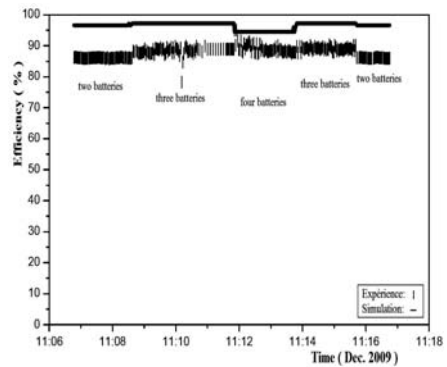

Boost converter efficiency

Fig. 8: Experience ( $\square$ ) and simulation ( $—$ ), when the number of panels in parallel varies for a solar irradiation:  $950 \text{ W/m}^2$ ,  $T: 20^\circ \text{C}$ .

Fig. 9: Experience ( $\square$ ) and simulation ( $—$ ), when the number of batteries in series varies for a solar irradiation:  $950 \text{ W/m}^2$ ,  $T: 20^\circ \text{C}$ .

#### 4. CONCLUSION

In this article, we analyzed in Pspice and characterized the electrical operation of the photovoltaic (PV) panels and systems where the MPPT command, low cost, it's analogical.

The results obtained show that the panels model depend on the solar radiation: when the solar radiation increases from  $300 \text{ W/m}^2$  to  $1000 \text{ W/m}^2$ , the optimal voltage of PV panels decreases by 12 %.

The association in parallel (series) of the panels induced the degradation (amelioration) performance of the panels. We qualitatively attributed this to the leakage current of the PV cells diodes: increase (decrease) leakage current induces the degradation (amelioration) of electrical performance.

The PV system designed and realised during this work presents a very interesting performance and a very dynamic stability towards the weather and load variations. Based on the Pspice simulator we have concluded:

- The validation of modelling results of PV panels
- Instantaneous convergence to the MPP in depending of the PV panels associated in parallel or in series, and the number of the batteries associated in series,
- A very good operation of the MPPT command,
- The good value of DC-DC converter Boost efficiency (above 85%).

All results obtained in this work are a contribution in the photovoltaic field to better exploit the solar energy.

#### ACKNOWLEDGMENT

This work is supported by:

- du Programme Thématique d'Appui à la Recherche Scientifique (PROTARS III) 'D43/06,
- Coopération Morocco-Belge '*Commission Universitaire Institutionnelle*', CUI-Oujda 2008-2012 (Activité Eau et Environnement / sous-activité Energies Renouvelables).

#### REFERENCES

- [1] A. Woyte, T. Vu Van, B. Ronnie and N. Johan, '*Voltage Fluctuations on Distribution Level Introduced by Photovoltaic Systems*', IEEE Transactions on Energy Conversion, Vol. 21, N°1, March 2006
- [2] M.F. Shraif, '*Optimisation et Mesure de Chaîne de Conversion d'Energie Photovoltaïque en Energie Electrique*'. Doctorat de l'Université Paul Sabatier, Toulouse, France, 2002.
- [3] K. Kassmi, M. Hamdaoui and F. Olivié, '*Caractérisation des Panneaux Photovoltaïques. Conception et Optimisation d'un Système Photovoltaïque pour une Meilleure Exploitation de l'Energie Solaire*', Energies Renouvelables, Organisation des Nations Unies pour l'Education, la Science et la Culture', Bureau de l'UNESCO à Rabat, Bureau Multi pays pour le Maghreb, Les Energies Renouvelables au Maroc, Le débat est lancé. Rabat, Morocco, ISBN9954\_8068\_2\_2, pp. 87 - 110, 2007.



- [4] M. El Ouariachi, T. Mrabti, B. Tidhaf, Ka. Kassmi and K. Kassmi, 'Regulation of the Electric Power Provided by the Panels of the Photovoltaic Systems', International Journal of Physical Sciences, Vol. 4, N°5, pp. , 2009.
- [5] T. Mrabti, M. El Ouariachi, K. Kassmi, F. Olivié et B. Bagui, (2008), 'Amélioration du Fonctionnement des Systèmes Photovoltaïques suite aux Brusques Variations des Conditions Météorologiques et de la Charge', Revue des Energies Renouvelables, Vol. 11, N°1, pp. 107 - 117, 2008.
- [6] H. Al-Atrash, I. Batarseh and K. Rustom, 'Statistical Modelling of DSP Based Hill-Climbing MPPT Algorithms in Noisy Environments', Twentieth Annual IEEE Applied Power Electronics Conference and Exposition, APEC 2005, Vol. 3, pp. 1773-1777, 6-10 March 2005.
- [7] K. Kassmi, M. Hamdaoui et F. Olivié, 'Maîtrise de l'Energie dans la Construction et la Rénovation des Bâtiments', Centre d'Etudes Supérieures Industrielles, 'CESI', Rouen, France, 8 Novembre 2007.
- [8] A.B.G. Bahgat, N.H. Helwa, G.E. Ahmad and E.T. El Shenawy, 'Maximum Power Point Tracking Controller for PV Systems Using Neural Networks', Renewable Energy, Vol. 30, N°8, pp. 1257 - 1268, 2005.
- [9] T. Tafticht, K. Agbossou, M.L. Dombia and A. Cheriti, 'An Improved Maximum Power Point Tracking Method for Photovoltaic Systems, Renewable Energy, Vol. 33, N°7, pp. 1508 - 1516, 2008.
- [10] M. El Ouariachi, T. Mrabti, B. Tidhaf, Ka. Kassmi, F. Bagui and K. Kassmi, 'Regulation of the Electric Power Provided by the Panels of the Photovoltaic Systems', International Conference on Multimedia Computing and Systems, ICMCS'09, IEEE, Ouarzazate, Morocco, April 02-04, 2009.
- [11] T. Mrabti, M. El Ouariachi, K. Kassmi, Ka. Kassmi and F. Bagui, 'Regulation of the Electric Power of the Photovoltaic Generators with DC-DC Converter (Buck Type) and MPPT Command', International Conference on Multimedia Computing and Systems, ICMCS'09, IEEE, Ouarzazate, Morocco, April 02-04, 2009.
- [12] M.C. Alonso-Garcia and J.M. Ruiz, 'Analysis and Modelling the Reverse Characteristic of Photovoltaic Cells', Solar Energy Materials and Solar Cells, Vol. 90, N°7-8, pp. 1105 - 1120, 2006.
- [13] S.M. Sze, 'Physics of Semiconductors Devices', J. Wiley, Interscience Publication, NewYork, 1981.
- [14] Z.M. Salameh, F. Dagher and W.A. Lynch, 'Step-Down Maximum Power Point Tracker for Photovoltaic Systems', Solar Energy, Vol. 46, N°5, pp. 279-282, 1991.
- [15] T. Mrabti, M. El Ouariachi, K. Kassmi, K. Kassmi, F. Olivié et F. Bagui, 'Conception, Modélisation et Réalisation d'un Système Photovoltaïque pour une Meilleure Exploitation de l'Energie Solaire', Maîtrise et Management des Risques Industriels, 'M2RI-08', Ecole Nationale des Sciences Appliquées, Oujda, Maroc, 24 et 25 Avril 2008.

- [16] T. Mrabti, M. El Ouariachi, Ka. Kassmi, K. Kassmi and B. Tidhaf, '*Characterization and Fine Modelling of Electric Operation of Photovoltaic Panels*', Scholars Research Library, Archives of Physics Research, (ISSN 0976-0970), Vol. 1, N°1, pp. 1 - 11, 2010.