

Direct Drive Wave Energy Converters

N. J. Baker and M. A. Mueller

School of Engineering, University of Durham, South Road, Durham, DH13LE, UK
E-mail: n.j.baker@durham.ac.uk

Abstract – *Over the last 25 years there have been numerous proposals for the conversion of energy contained within sea waves into electricity. Despite this fact, there is not yet one definitive wave energy device that stands out from the rest and developments in several concepts still continues. One aspect of a wave energy converter is the manner in which the physical movement of the device is converted into electrical energy. This paper investigates the concept of direct drive wave energy converters, whereby the moving part of a wave energy converter is coupled directly to the moving part of an electrical generator. This eliminates the need for intermediate mechanical devices such as turbines and hydraulic systems.*

Résumé – *Durant ces 25 dernières années il y a eu plusieurs propositions de convertir l'énergie contenue dans les vagues de la mer en énergie électrique. Malheureusement, il n'y a pas eu encore un dispositif d'énergie de vagues qui aurait émergé comme solution définitive ; c'est pourquoi, différentes méthodes sont considérées pour l'élaboration d'un prototype. Le concept du convertisseur d'énergie de vagues repose sur la conversion du mouvement physique, produit par les vagues et mesurer par le dispositif, en énergie électrique. Cet article, examine l'idée de commande direct des convertisseurs d'énergie de vagues, alors que la partie mobile du convertisseur d'énergie de vagues est liée directement à la partie mobile d'un générateur électrique. Ceci évite l'utilisation d'un système mécanique intermédiaire tel qu'une turbine et un système hydraulique.*

Keywords : Sea waves – Converter – Electrical energy.

1. INTRODUCTION

The concept of utilising the energy contained within sea waves for electricity production is not new. Present estimates show that 11-15% of the UK's electricity demands can be met by the energy in UK waters [1], and the worldwide resource is 10 TW in open sea [2]. Many devices have been proposed to capture the energy in the waves, all of which result in a reciprocating motion at low velocities in the region of 0.5 to 1 m/s. Heaving buoy type devices produce linear motion whereas a nodding device such as the Duck produces a circular motion. Wave energy devices are not directly compatible with off the shelf conventional rotary electrical machines. Air & water turbines and hydraulic systems have been proposed to interface the wave energy device with the electrical generator. However these interfaces increase the complexity of the system and introduce reliability issues, which are of prime importance in an offshore environment.

This paper introduces the concept of 'direct drive' wave energy converters, whereby the moving part of a wave energy device is coupled directly to the moving part of a reciprocating electrical generator. Direct drive systems are becoming more common place in wind energy, where the airgap speed is in the region of 6-10 m/s, still significantly higher than in a wave energy converter. The development of high energy density permanent magnets such as Neodymium-Iron-Boron (Nd-Fe-B), has led to the development of some innovative machine topologies.

The harsh offshore environment demands systems that are essentially maintenance free, which implies the use of brushless machines. In order to achieve sufficient flux density levels in the airgap an induction machine requires a minimum pole pitch in the region of 150 mm. With the low speeds expected in wave energy devices requiring a large number of poles, a very large machine would result. Reluctance machines require small airgaps to optimise the difference between the aligned and un-aligned inductances. Owing to manufacturing tolerances small airgaps are difficult to maintain in very large machines. Induction machines and reluctance machines are therefore not considered further in this paper.

Permanent magnet machines offer the best solution. In the early seventies Professor Salter considered the possibility of a low speed PM generator for the Duck, but after consultation with Professor Eric Laithwaite and some quick calculations the idea was abandoned because the generator would be too heavy and the device would sink [2]. Today, a direct drive system is more feasible.

2. WAVE ENERGY CONVERTERS FOR DIRECT DRIVE

The basic system for a direct drive wave energy converter is shown in figure 1.

This shows a simple heaving buoy device, whereby a float, which is designed to follow the movement of the water surface, is directly coupled to the moving part of a linear generator, referred to as the translator. The second part of this generator is mounted onto a submerged drag plate, situated below the action of the surface waves (95% of the energy contained within the wave is in the region between the mean water depth and one quarter of a wavelength below it). The added hydraulic resistance of this plate and the buoyancy of the float are the two opposing forces from which energy can be extracted.

Inspection of this device clearly shows its simplicity, and the fact that there is only one moving part implies its reliability.

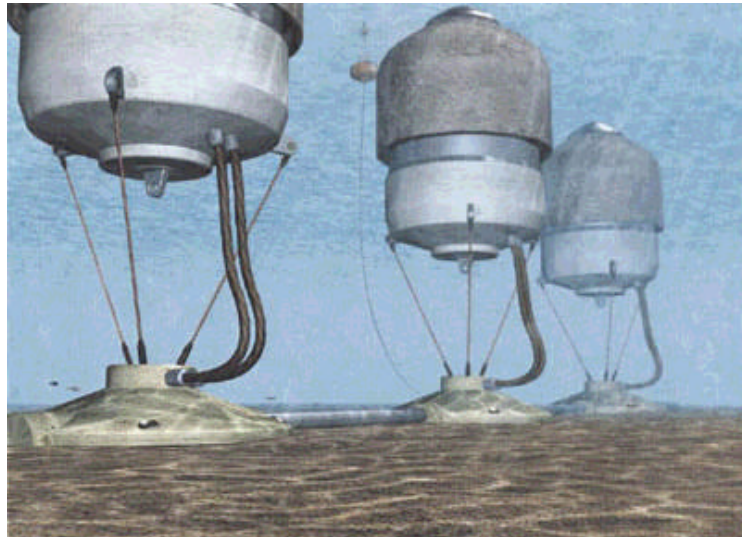

Fig. 1: A Simple direct drive wave energy converter

2.1. Archimedes wave swing

This device is mounted on the seabed and consists of an air filled chamber, which has freedom to move in a vertical plain relative to its base.

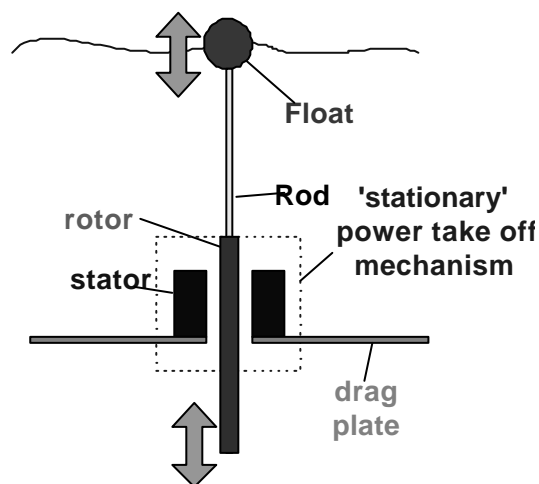

Fig. 2: Archimedes wave swing [3]

The fully submerged chamber is not exposed to the dangerous slamming forces experienced by floating devices. As a wave crest passes over one of these devices, the added depth of water causes an increase in water pressure surrounding the device. Air is then allowed to pass out of the float into a second chamber, and hence the entire hood of the device will fall.

The device will rise again when a trough passes over the device and the net result is hence slow speed reciprocating linear motion. An array of these devices is shown in figure 2.

Given that the hood of the device is an air pocket, the conditions are very suitable to install a device with minimal support equipment or corrosion protection. A 2MW prototype is currently being built and is to be commissioned off the coast of Portugal this summer. The inventor intends using a 3-phase permanent magnet (PM) linear synchronous machine directly coupled to the wave energy device. Details of the generator design were presented at ICEM 2000 by Pollinder et al [4].

This device is clearly already classified as a direct drive wave energy converter.

2.2. Inter project service (IPS) Buoy

The basic structure of this device consists of a semi submerged float coupled to a totally submerged hollow tube, open to the sea at both ends, figure 3. Part of this tube forms a cylinder enclosing a piston connected to a rod. Relative motion between the rod and the float forms the basis for power take off.

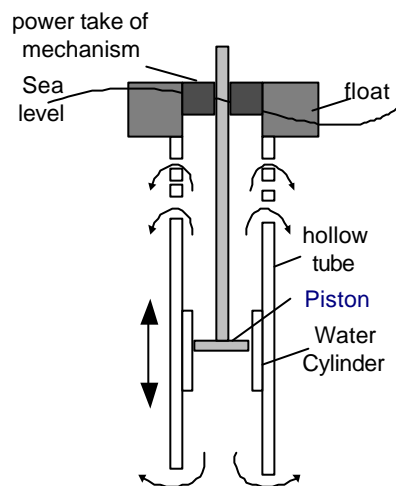

Fig. 3: Cross section of IPS buoy

If the amplitude of oscillation becomes too large and the piston moves out of the cylinder, it effectively becomes decoupled from the mass of the surrounding water and starts acting as a drag plate. This allows the piston and rod assembly to follow the oscillation of the tube, which hence acts as an in-built protection against the power take off mechanism being damaged. Most devices would require some form of end-stop protection to achieve this.

Salter et al have proposed inclining the device [5] in order to alter the buoyancy and hence bandwidth of the device. This will increase the proportion of the energy that can be absorbed from a given sea state without the need for a complex control strategy. A further advantage with this device is derived from the fact that both the submerged tube and the heaving buoy are mutually buoyant. This means any lateral forces experienced are greatly reduced.

In the current proposals, the water pistons are coupled to high pressure oil rams [6] that are intended to drive the electrical system. It is easy to see how these could be replaced with linear electrical machines. Indeed, a linear induction motor is being used in small scale test models at the University of Edinburgh to provide damping.

2.3. Duck

This device, first conceived in 1974 [7], has been very well covered in other areas but is worth mentioning here as it is one of the few devices that is suitable for direct drive but produces rotary, not linear, motion. The concept involves a cam shaped device allowed to move in two degrees of freedom floating on the water surface, constrained only by a

rotary spine. The shape of the float, as shown in figure 4, is such that it is able to absorb 100% of the energy contained in a wave, a claim not shared by many wave energy converters.

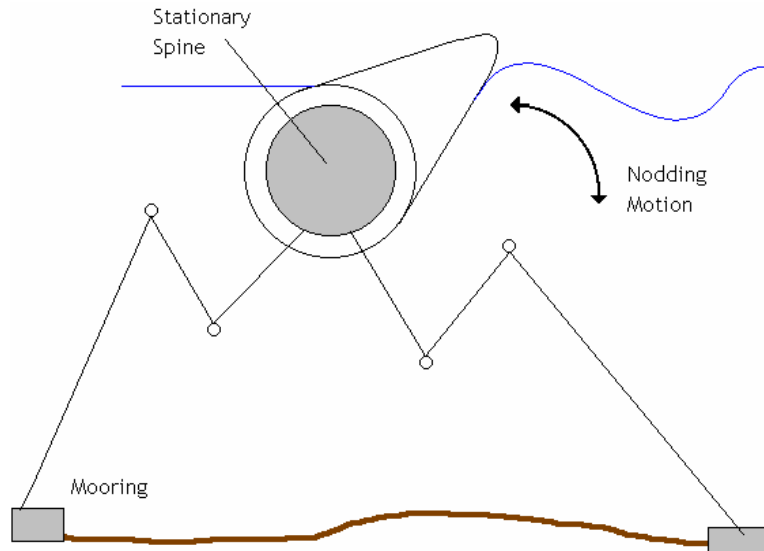

Fig. 4: Salter's Duck

In a direct drive device, the permanent magnets and copper coils could be mounted on the spine of the device, and the rotor coupled to the moving cam. The relative reciprocating motion between these two elements would hence constitute the only moving parts.

3. ELECTRICAL MACHINE TOPOLOGY

The specific shear stress, and thus force, developed in the airgap of a machine provides a valid basis on which to assess machine topologies. The shear stress is proportional to the product of the magnetic and electric loading, which are respectively limited by magnetic saturation and temperature rise in the windings. Conventional PM machines produce a typical shear stress of 20-25 kN/m². Various authors have shown that the shear stress can be increased by a new topology of machines collectively known as variable reluctance permanent magnet machines (VRPM) [8].

3.1. Variable reluctance permanent magnet machines

Various topologies of VRPM machines have been described [8,9,10,11]. The basic topology consists of magnets with small pole pitch moving relative to a toothed structure. An example of a single phase linear machine is shown in figure 5.

In the position shown 3 translator poles are fully aligned with 3 magnets of one polarity on one limb and another 3 of opposing polarity on the facing limb. The reluctance offered is a minimum, and so flux flows through the steel core, across the airgap, through the translator poles across the opposite airgap and into the opposing magnets in the translator core back. When the translator moves one tooth pole pitch the polarity of the flux changes sign producing a rapid flux reversal. The low velocity of the translator is geared up to a high electrical frequency. During the flux reversal an energy change takes place over a small distance, resulting in high thrust forces at the airgap.

The transverse flux machine (TFM) is the ultimate VRPM machine with peak shear stresses in the region of 200 kN/m² being reported [11], orders of magnitude greater than conventional machines. A study comparing the TFM to conventional PM machines shows the benefit of the former for direct drive wave energy converters in terms of physical size [12]. However, the topology results in a non-standard support structure, which is difficult to assemble. The topology shown in figure 5 resembles the structure of a more conventional machine. Experimental results on rotary machines at Durham show a mean shear stress less than the TFM, but greater than conventional PM machines.

Proposals for a VRPM machine rated at 100 kW at 2m/s speed give a machine of width around 200 mm, depth 600 mm and height of 1 m. With a three metre length translator suited to small waves, this gives a machine with force density of 46N/kg and power density of 93 W/kg.

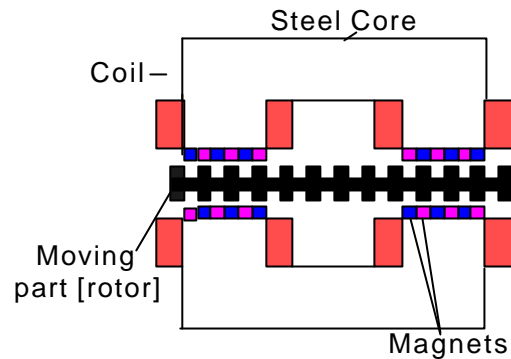

Fig. 5: A single phase linear VRPM machine

4. ELECTRICAL SYSTEM ISSUES

The motion of a wave energy device results in a sinusoidal velocity variation, which has a pronounced effect on the induced emf in electrical generator. As can be seen in figure 6 the emf varies in amplitude and frequency during a wave cycle, typically 10s.

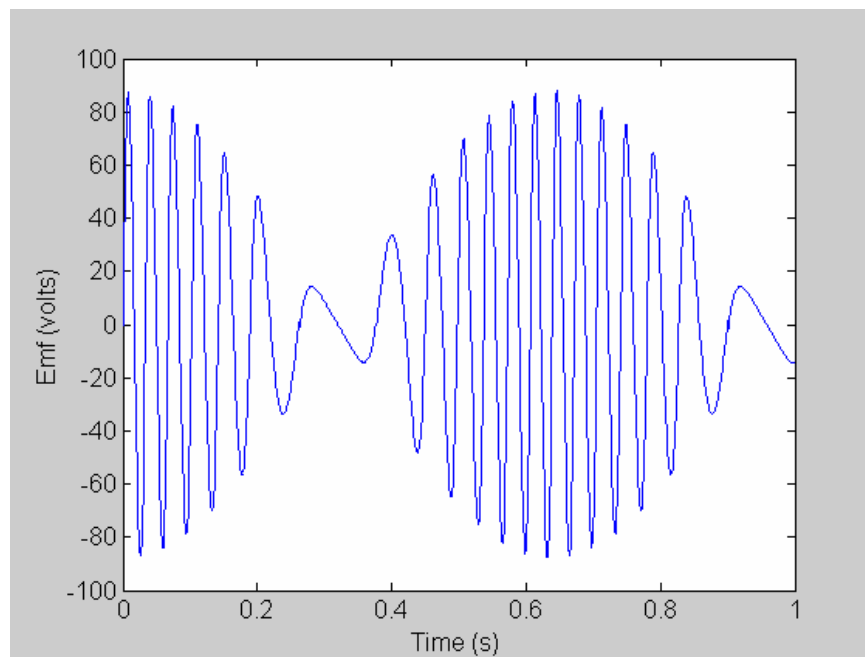

Fig. 6: Typical Emf plot when VRPM is excited by a sine wave displacement

The frequency depends upon the velocity and the pole pitch of the magnets. Clearly some form of signal processing is required before grid connection.

In order to change the polarity of the flux reactive power is drawn from the supply. At the terminals this is observed as a large inductance, which gives rise to high voltage regulation at the load. A similar problem was observed by Chen et al in modular PM machines for direct drive wind turbines. The problem was overcome using capacitor assisted

excitation. Maximum load power occurs if the capacitor connected across the generator terminals is chosen according to [14]:

$$C = \frac{L}{\omega^2 L^2 + R^2}$$

where L & R are the inductance and winding resistance respectively.

A fixed capacitance will only have benefits at a single resonant frequency, but the electrical frequency will clearly vary. Therefore, in order to benefit from assisted excitation at all frequencies, thyristor switched capacitors would have to be used (e.g. SVC), or a combination of a fixed capacitor and an active rectifier.

The power absorbed by a wave energy device varies cyclically :

$$P = \hat{P}(1 - \cos 2\omega_s t)$$

The output power from the generator is therefore far from smooth. It is anticipated that an array of devices would be used to provide some smoothing alongside some form of energy storage. Overall the electrical system for a single device consists of the blocks shown in figure 7. All devices in an array would be connected to a common dc bus, with an inverter on shore for grid connection.

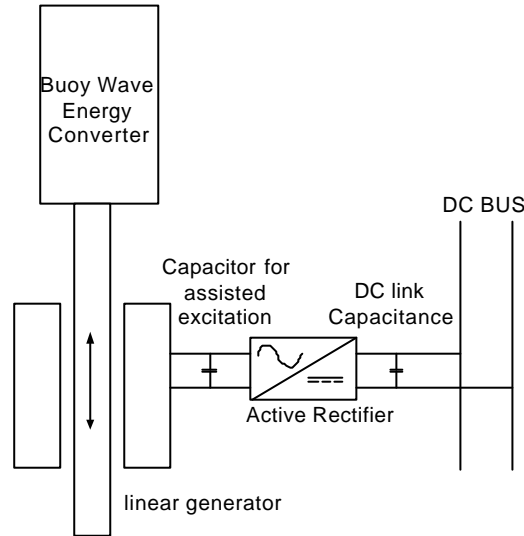

Fig. 7: Electrical system of direct drive wave energy converter

5. PHYSICAL INTEGRATION ISSUES

The primary issues of concern are the support and lubrication of the generator, and the problem of corrosion. Large radial forces are produced between the stator and translator, which can be calculated from Maxwell stress :

$$F = \frac{B^2}{2\mu_0} \quad \text{N/m}^2$$

where B is the flux density (T) and μ_0 is the permeability of free space.

In a double sided linear machine the net force on the translator is zero provided the airgap on either side is the same. However the stator sections must be supported to be able to react the radial force. Structural analysis presented in [15] shows that a significant support structure is required leading to a reduction in the power density and force density. For example the 100kW machine mentioned earlier could be expected to have power density reduced to 75 W/kg when the support structure is included. The corresponding change in force density is a reduction to 37 N/kg.

Bearings provide lubrication for the translator and will have to react any residual forces arising from an airgap imbalance. The choice of bearings for a linear machine is not straight forward. The possibility of using a hydrostatic bearing slide way is currently being investigated. In this situation, the moving parts of the structure are separated by a thin layer of pressurised water, which actually eliminates wear and prolongs the expected lifetime of a device. A self regulating design is being considered to automatically compensate for net forces on the translator, due either to a change in airgap or resulting from the sea. With this bearing configuration the machine will run flooded – corrosion now becomes an issue.

Corrosion can be overcome with appropriate coatings. Coal tar epoxy is used throughout the marine industry to protect steel. A PM manufacturer offers two coatings : a 15 μm electro coating and a 5 μm aluminium yellow chromate coating [16]. A ceramic coating, ceramax, used by the hydraulics industry has a proven reputation in the marine environment [17]. Insulation breakdown in a flooded environment is clearly a problem. These corrosion issues are being addressed through experimental work at Durham.

6. CONCLUSION

The concept of wave energy has been outlined and some previously proposed devices for harnessing it presented. Some of the issues associated with the direct coupling of the moving element of one such wave energy converter to the translator of a linear generator designed to be run at low speeds have been described.

Acknowledgements – The authors would like to thank the EPSRC for funding the research and the University of Durham for providing facilities.

REFERENCES

- [1] G. Boyle, “*Renewable Energy Power for a Sustainable Future*”, Open University Press.
- [2] D. Ross “*Power from the Waves*”, Oxford University Press, 1995, ISBN 0 19 856511 9
- [3] <http://www.sustdev.org/journals/edition.01/preview/1.113.shtml>
- [4] H. Polinder, F. Gardner, B. Vriesema, “*Linear PM Generator for Wave Energy Conversion in the AWS*”, Proc of the International Conference on Electrical Machines , pp 309-313, August 2000, Espoo, Finland.
- [5] S. H. Salter and Chiao-Po Linn, “*The Sloped IPS Wave Energy Converter*”, Proceedings of the second European Wave Power Conference, 1995, Lisbon pp337-44
- [6] J.R.M Taylor and I. Mackay, “*The Design of an Eddy Current Dynamometer for a Free-Floating Sloped IPS Buoy*”, Proceedings of Marine Renewable Energy Conference, Newcastle, March 2001 ISBN 1-902536-43-6, pp67-74
- [7] S. H. Salter, “*Wave Power*”, Nature Vol 249 (1974) pp720-724
- [8] M. R. Harris and B. C. Mecrow, “*Variable Reluctance Permanent Magnet Motors for High Specific Output*”, Proc. IEE Conference on Electrical Machines & Drives, Oxford, 1993
- [9] H. Weh, H. Hoffman and J. Landrath, “*New Permanent Magnet Excited Synchronous Machine with High Efficiency at Low Speeds.*”, Proc. Int. Conf. Elec. Machines, Pisa, Italy, Sept. 1988, pp 35-40.
- [10] M. R. Harris, G. H. Pajooman and S. M. Abu Sharkh, “*The Problem of Power Factor in VRPM (Transverse Flux) Machines.*”, Proc. IEE Conference on Electrical Machines & Drives, Cambridge, 1997.
- [11] N. Iwabuchi, A. Kawahara, T. Kume, T. Kabashima and N. Nagasaka, “*A Novel High-Torque Reluctance Motor with Rare-Earth Magnet*”, *IEEE Transactions on Industry Applications*, Vol. 30, No. 3, May/June, 1994.
- [12] M. A. Mueller, N. J. Baker, and E. Spooner, “*Electrical Aspects of Direct Drive Wave Energy Converters*”, Fourth European Wave Energy Conference, Aalborg, Denmark, December 2000
- [13] N. Iwabuchi, A. Kawahara, T. Kume, T. Kabashima and N. Nagasaka, “*A Novel High-Torque Reluctance Motor with Rare-Earth Magnet*”, *IEEE Transactions on Industry Applications*, Vol. 30, No. 3, May/June, 1994.
- [14] Z. Chen, E. Spooner, W. T. Norris and A. C. Williamson, “*Capacitor-Assisted Excitation of Permanent Magnet Generators*”, *IEE Proc. Electr. Power Appl.*, Vol. 145, No. 6, November 1998.
- [15] N. J. Baker, and M. A. Mueller, “*Design and Integration of Linear Generators into Direct Drive Wave Energy Converters*”, Proceedings of Marine Renewable Energy Conference, Newcastle, March 2001 ISBN 1-902536-43-6
- [16] Company Literature Vacuumschmelze, Hanau, Germany, <http://www.vacuumschmelze.de>
- [17] Rexroth Hydraulics company literature, <http://www.rexroth.com/riq/1999/riq.1999-3/en/article8.pdf>